

Stojaté liatinové telesá typu SG

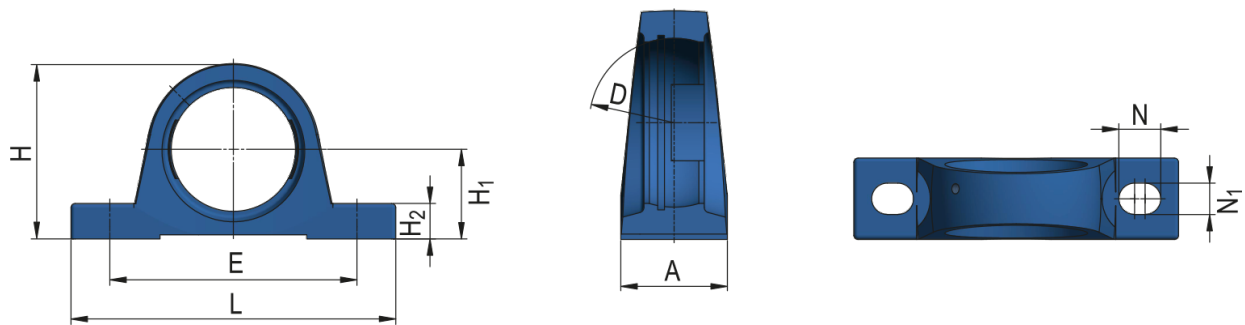

Označenie telesa

SG206; SGC206

Rozmery (mm)

A	46
D	62
E	121
L	163
H	82
H ₁	42,9
H ₂	17
N	21
N ₁	17

Hmotnosť [kg]

0,850