

# Stojaté liatinové telesá typu SG

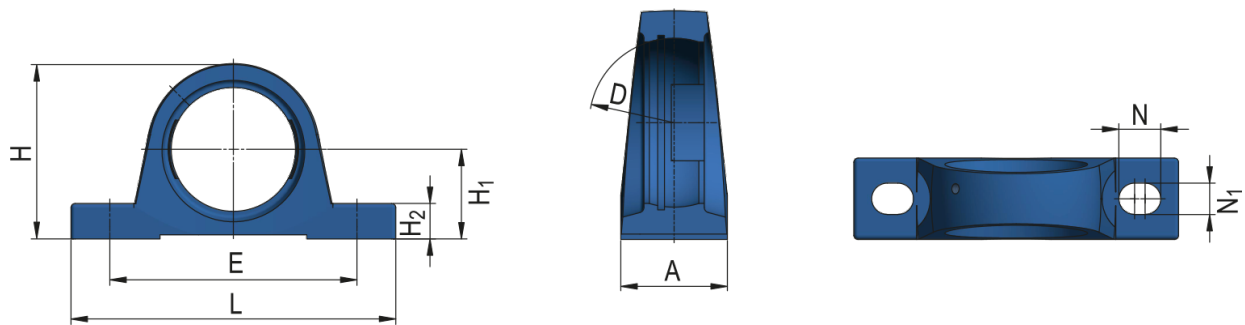

Označenie telesa

SG216; SGC216

## Rozmery (mm)

A	77
D	140
E	231
L	290
H	174
H <sub>1</sub>	88,9
H <sub>2</sub>	33
N	30
N <sub>1</sub>	25

Hmotnosť [kg]

4,99