

# Stojaté liatinové telesá typu SG

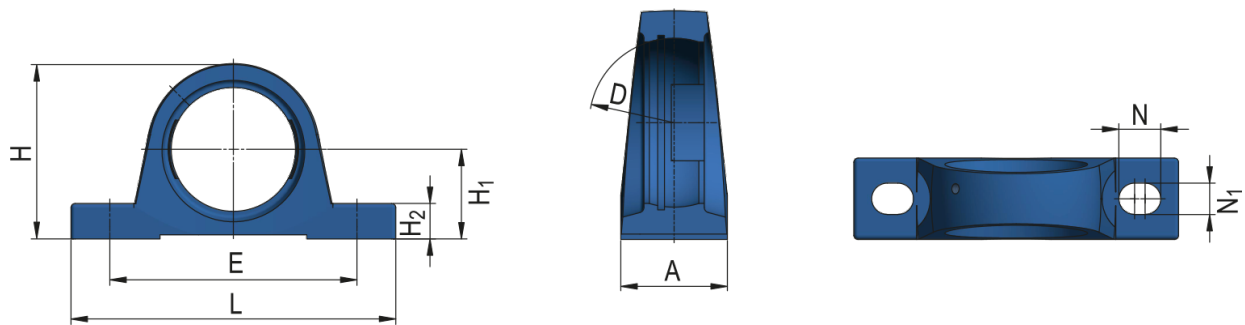

Označenie telesa

SG203; SGC203

## Rozmery (mm)

A	32
D	40
E	95
L	125
H	57
H <sub>1</sub>	30,2
H <sub>2</sub>	14
N	17
N <sub>1</sub>	12

Hmotnosť [kg]

0,360