

# Ending nuts

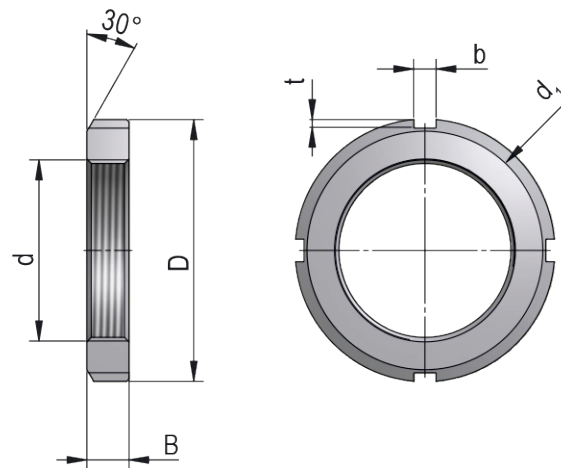

Sleeve Designation

**KM19**

Appropriate Components

Locking Washer

**MB19**

## Dimensions (mm)

d	M95x2
d <sub>1</sub>	113
D	125
B	17
b	10
t	4
	-

Weight [kg]

0,650