

Adapter sleeves

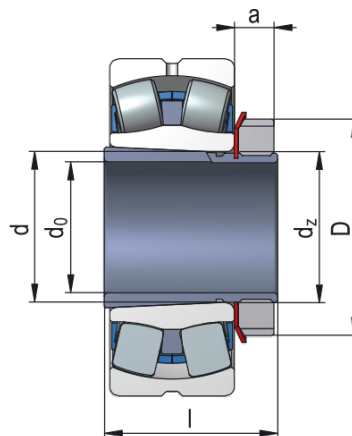

Sleeve Designation	H303
---------------------------	-------------

Appropriate Components	
Nut	KM3
Washer	MB3

Dimensions (mm)

d_0	14
d	17
D	28
l	24
a	6
a_1	-
d_z	M17x1
d_{z1}	-

Weight [kg]	0,036
--------------------	-------