

Adapter sleeves

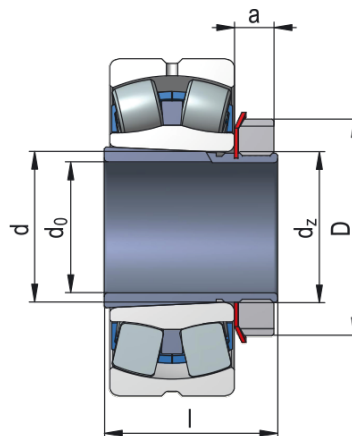

Sleeve Designation	H2306
---------------------------	--------------

Appropriate Components	
Nut	KM6
Washer	MB6

Dimensions (mm)

d_0	25
d	30
D	45
l	38
a	8
a_1	-
d_z	M30x1,5
d_{z1}	-

Weight [kg]	0,120
--------------------	-------