

# Oval Flanged Cast Housing Unit - FM type

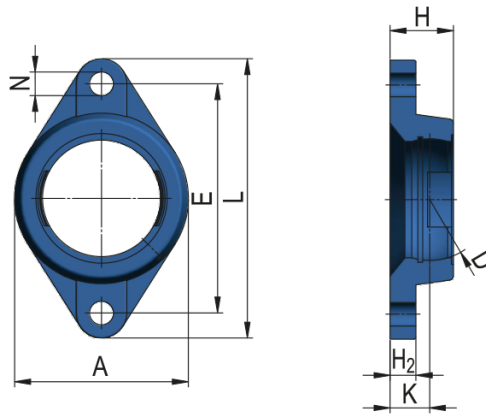

Housing Unit Designation

**FM211; FMC211**

## Dimensions (mm)

A	128
D	100
E	184
L	222
H	43
K	25
H <sub>2</sub>	18
N	19

Weight [kg]

1,66