

# Pillow Block Housing Unit - SG type

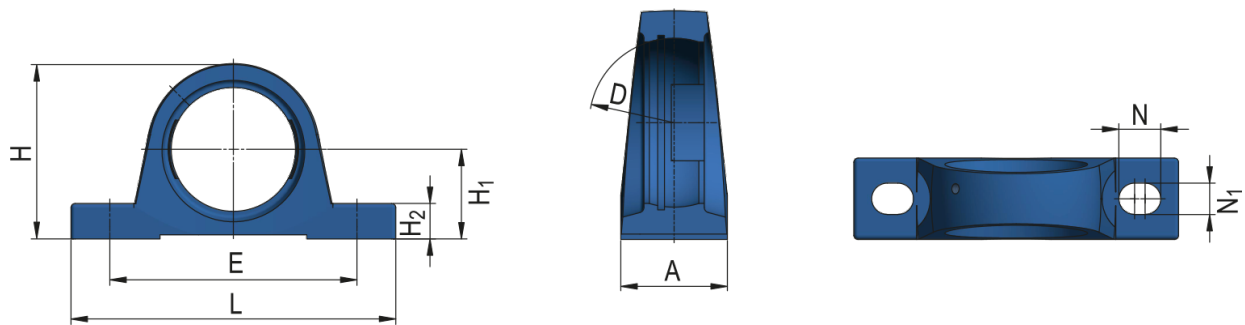

Housing Unit Designation

**SG216; SGC216**

## Dimensions (mm)

A	77
D	140
E	231
L	290
H	174
H <sub>1</sub>	88,9
H <sub>2</sub>	33
N	30
N <sub>1</sub>	25

Weight [kg]

4,99