

Spherical plain bearings

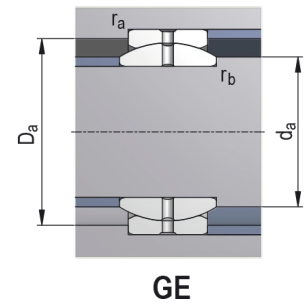
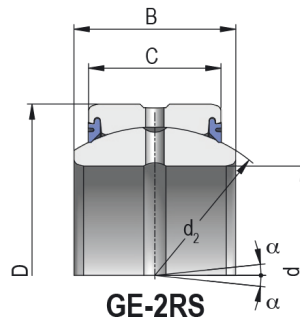
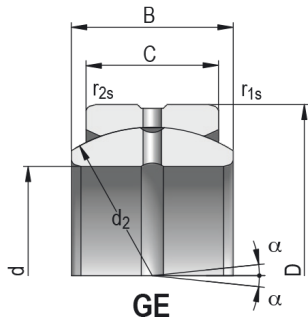

Bearing Designation **GE40E; GE40E-2RS**

Dimensions (mm)

d	40
D	62
B	28
C	22

d ₂	53
r _{1s} min	0,6
r _{2s} max	1
α°	7

Basic Load Rating (kN)

C	99
C ₀	495

Radial Clearance normal (mm)

min	0,06
max	0,12

Abutment and Fillet Dimensions (mm)

d _a min	45
D _a max	57
r _a max	0,8
r _b max	0,6

Weight [kg]	0,308
-------------	-------

Tolerance Class

Tolerance Class	Inner Ring														
	Cylindrical Bore									Tapered Bore 1:12					
	Δ_{dmp}		V			V_{dmp}	K_{ia}	Δ_{BS}		V_{BS}	Δ_{dmp}		$\Delta_{d1mp} - \Delta_{dmp}$		$V_{dp}^{1)}$
			Diameter Series												
	max	min	7,8,9	0,1	2,3,4	max	max	max	min	max	min	max	min	max	
μm															
P0	0	-12	15	12	9	9	15	0	-120	20	-	-	-	-	-
P6	0	-10	13	10	8	8	10	0	-120	20	25	0	25	0	15

Tolerance Class	Inner Ring										
	Tapered Bore 1:12					Tapered Bore 1:30					
	Δ_{dmp}		$\Delta_{d1mp} - \Delta_{dmp}$		$V_{dp}^{1)}$	Δ_{dmp}		$\Delta_{d1mp} - \Delta_{dmp}$		$V_{dp}^{1)}$	
											max
	max	min	max	min	max	max	min	max	min	max	
μm											
P0	25	0	25	0	15	-	-	-	-	-	

Tolerance Class	Outer Ring									
	Δ_{Dmp}		V_{Dp}				V_{Dmp}	K_{ea}	Δ_{CS}, V_{CS}	
			Diameter Series			bearings ²⁾ with seals				
	max	min	7,8,9	0,1	2,3,4		max	max		
	μm									
P0	0	-13	16	13	10	20	10	25	Corresponds to Δ_{BS}, V_{BS} of the same bearing inner ring	
P6	0	-11	14	11	8	16	8	13		

1) Valid in any bore radial plane

2) P0 - Valid only for bearings in diameter series 2, 3 and 4 * P6 - Valid only for bearings in diameter series 0, 1, 2, 3 and 4

Tolerance Symbols and Their Meaning

d	nominal bore diameter	H_4	rated height of spherical-roller bearing
d_1	nominal diameter of larger theoretical tapered bore diameter	Δ_{Bs}	inner ring single width deviation
d_2	nominal diameter of the shaft washer of double direction thrust bearings	Δ_{Cs}	outer ring single width deviation
Δ_{ds}	deviation of single bore diameter from nominal	Δ_{Is}	bearing single width deviation (total)
Δ_{dmp}	mean cylindrical bore diameter deviation in single radial plane (for tapered bore Δ_{dmp} is valid for theoretical bore diameter)	Δ_{T1s}	cone sub-unit effective width deviation
Δ_{d1mp}	deviation of mean larger theoretical diameter of tapered bore	Δ_{T2s}	cup sub-unit effective width deviation
Δ_{d2mp}	mean shaft washer bore diameter deviation of double direction thrust bearings in single radial plane	Δ_{Hs}	height deviation of single direction axial bearings from nominal value
V_{dp}	single bore diameter variation in single radial plane	Δ_{H1s}	height deviation of single direction axial ball bearings with sphered housing washer from nominal value
V_{dmp}	mean cylindrical bore diameter variation	Δ_{H2s}	height deviation of double direction axial bearings from nominal value
V_{d2p}	shaft washer bore diameter variation of double direction thrust bearings in single radial plane	Δ_{H3s}	height deviation of double direction axial ball bearings with sphered housing washer from nominal value
D	nominal outside diameter	Δ_{H4s}	height deviation of axial spherical-roller bearing from the rated value
Δ_{Ds}	deviation of single outside diameter from the nominal dimension	C	outer ring nominal width
Δ_{Dmp}	mean outside cylindrical surface diameter deviation in single plane	V_{Bs}	inner ring single width variation
V_{Dp}	single outside cylindrical surface diameter variation in single radial plane	V_{Cs}	outer ring single width variation
V_{Dmp}	mean outside cylindrical surface diameter variation	K^{ia}	radial runout of assembled bearing inner ring
B	inner ring nominal width	K^{ea}	radial runout of assembled bearing outer ring
T	total nominal width of tapered roller bearings	S_t^{ea}	shaft washer raceway axial runout
T_1	nominal effective width of cup sub-unit	S_t^e	housing washer raceway axial runout
T_2	nominal effective width of cone sub-unit	S_{ia}^e	inner ring flat seat face axial runout of assembled bearing
H	rated width of unidirectional axial bearing	S_{ea}^e	outer ring flat seat face axial runout of assembled bearing
H_1	rated height of unidirectional ball axial bearing including the body ring	S_d^{ea}	flat seat face axial runout
H_2	rated height of bidirectional axial bearing	S_D	runout of outside cylindrical surface towards outer ring face
H_3	rated height of bidirectional axial ball bearing including body rings	S_s	runout of supporting face towards seat face for single row tapered roller bearings